

Analog Devices Welcomes Hittite Microwave Corporation

NO CONTENT ON THE ATTACHED DOCUMENT HAS CHANGED



THIS PAGE INTENTIONALLY LEFT BLANK



GaAs pHEMT MMIC LOW NOISE AMPLIFIER, 0.3 - 20 GHz

Typical Applications

The HMC1049LP5E is ideal for:

- Test Instrumentation
- High Linearity Microwave Radios
- VSAT & SATCOM
- Military & Space

Features

- Noise Figure: 1.8 dB
- P1dB Output Power: +14.5 dBm
- Psat Output Power: +17.5 dBm
- High Gain: 15 dB
- Output IP3: +29 dBm
- Supply Voltage: Vdd = +7V @ 70 mA
- 50 Ohm Matched Input/Output
- 32 Lead 5x5 mm SMT Package: 25mm²

Functional Diagram

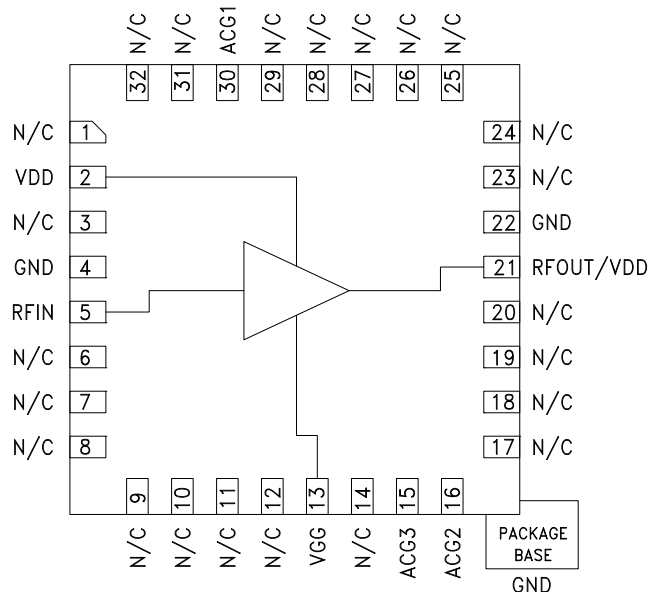

General Description

The HMC1049LP5E is a GaAs MMIC Low Noise Amplifier which operates between 0.3 and 20 GHz. This LNA provides 15 dB of small signal gain, 1.8 dB noise figure, and output IP3 of 29 dBm, while requiring only 70 mA from a +7 V supply. The P1dB output power of 14.5 dBm enables the LNA to function as a LO driver for balanced, I/Q or image reject mixers. Vdd can be applied to pin 2 or pin 21. Pin 21 will require a bias tee. The HMC1049LP5E amplifier I/Os are internally matched to 50 Ohms and the device is supplied in a compact, leadless QFN 5x5 mm surface mount package.

Electrical Specifications, $T_A = +25^\circ\text{C}$, $V_{dd} = +7\text{V}$, $I_{dd} = 70\text{mA}$ [1]

Parameter	Min.	Typ.	Max.	Min.	Typ.	Max.	Min.	Typ.	Max.	Units
Frequency Range		0.3 - 1		1 - 14			14 - 20			GHz
Gain	13.5	16.5		12	15		10	13		dB
Gain Variation Over Temperature		0.006			0.019			0.017		dB/°C
Noise Figure		2.5	3.5		1.8	2.5		2.7	4.0	dB
Input Return Loss		15			13			14		dB
Output Return Loss		8			15			13		dB
Output Power for 1 dB Compression (P1dB)		15			14.5			13		dBm
Saturated Output Power (Psat)		18			17.5			16		dBm
Output Third Order Intercept (IP3) [2]		31			29			26		dBm
Total Supply Current		70			70			70		mA

[1] Adjust Vgg between -2 to 0V to achieve Idd = 70 mA typical.

[2] Measurement taken at Pout / tone = +8 dBm.



**GaAs pHEMT MMIC LOW NOISE
AMPLIFIER, 0.3 - 20 GHz**

Data taken with Vdd applied to pin 2.

Broadband Gain & Return Loss

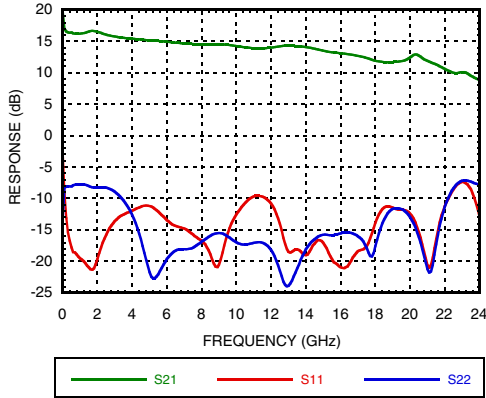

Gain vs. Temperature

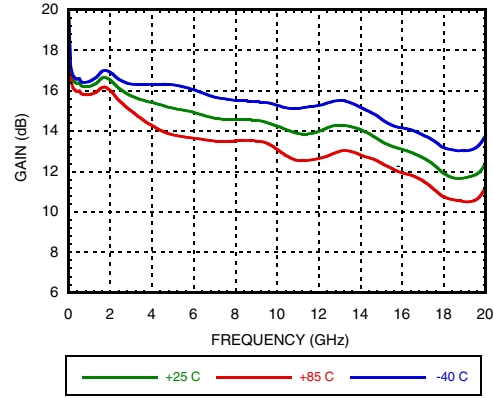

Input Return Loss vs. Temperature

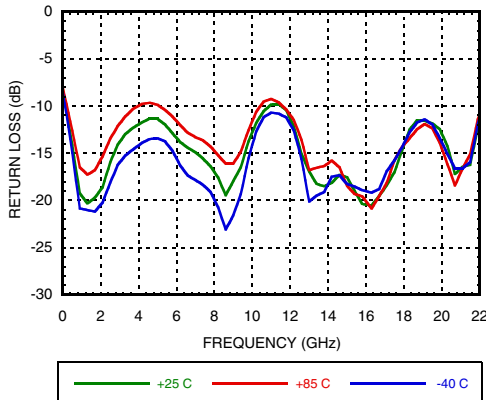

Output Return Loss vs. Temperature

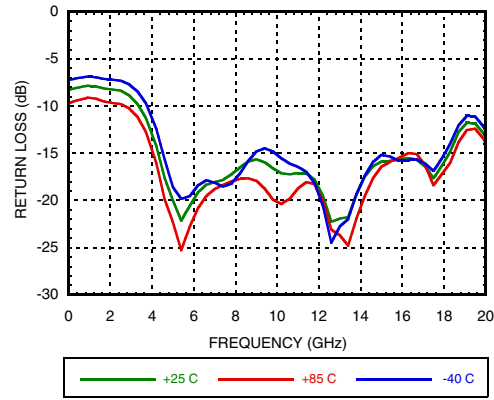

Noise Figure vs. Temperature

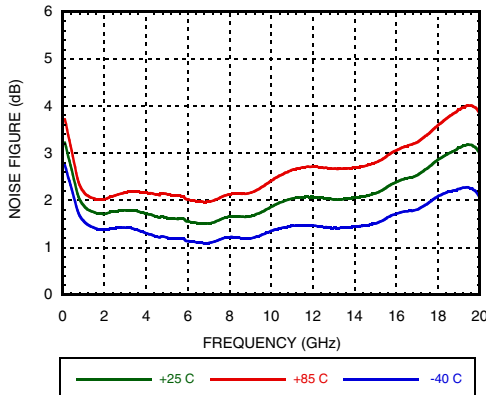

**Noise Figure vs. Temperature,
Low Frequency**

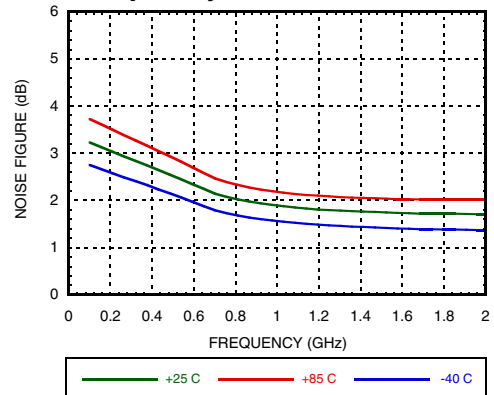



**GaAs pHEMT MMIC LOW NOISE
AMPLIFIER, 0.3 - 20 GHz**

Data taken with Vdd applied to pin 2.

Noise Figure vs. Vdd

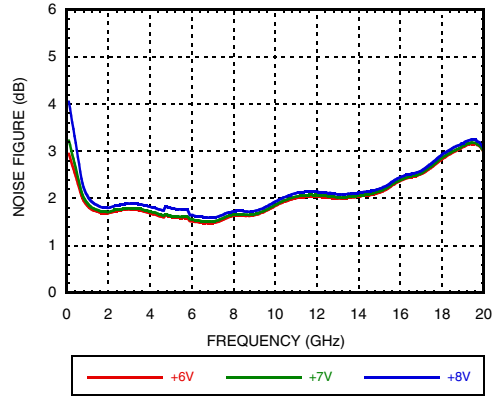

Noise Figure vs. Idd

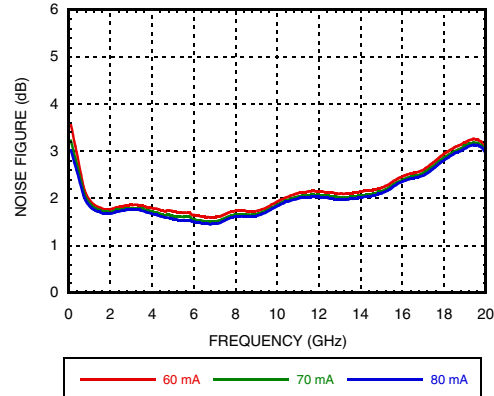

Output IP3 vs. Temperature

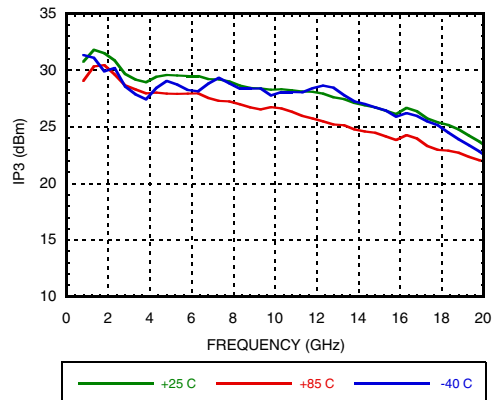

P1dB vs. Temperature

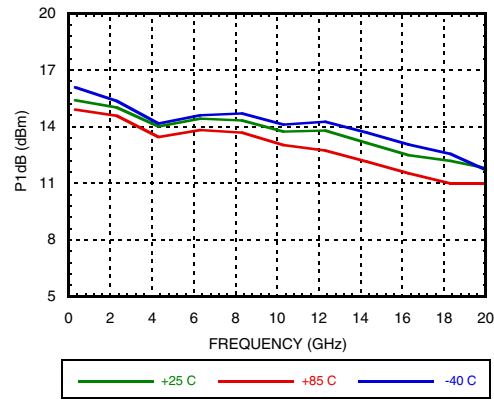

Psat vs. Temperature

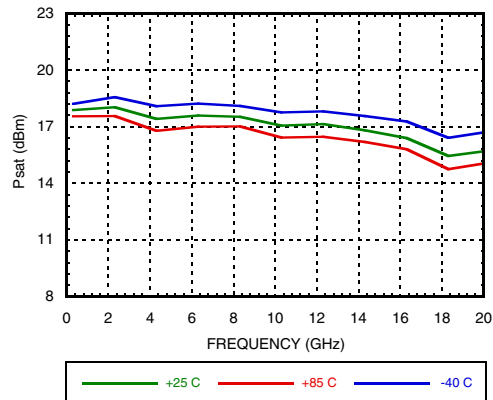

P1dB vs. Vdd

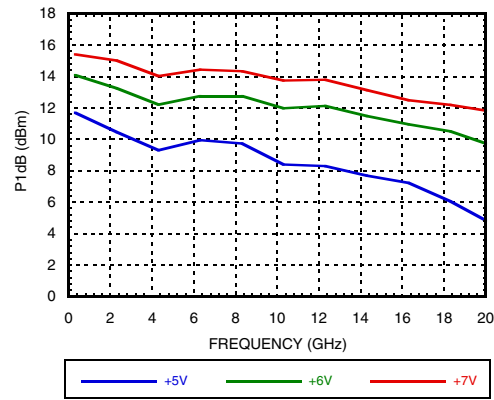



GaAs pHEMT MMIC LOW NOISE AMPLIFIER, 0.3 - 20 GHz

Data taken with Vdd applied to pin 2.

Psat vs. Vdd

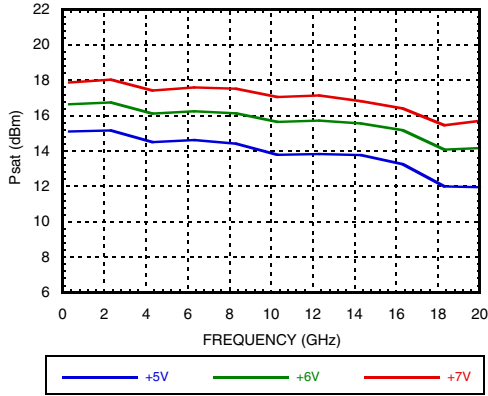

Reverse Isolation vs. Temperature

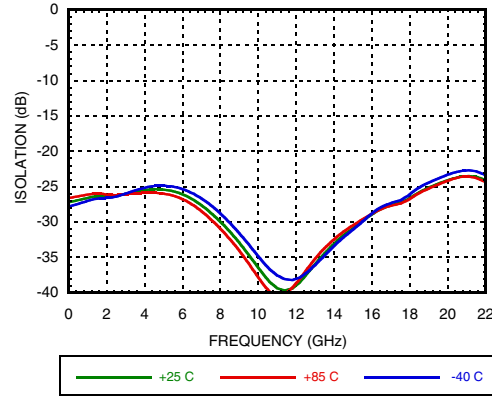

Power Compression @ 2 GHz

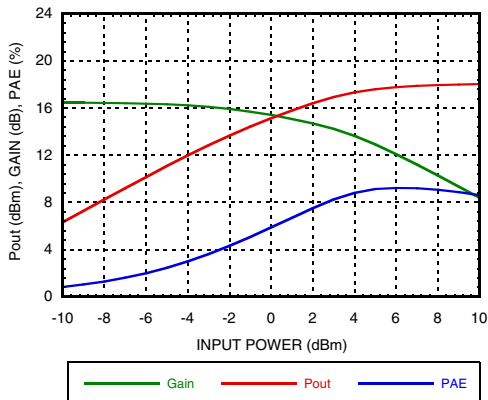

Power Compression @ 10 GHz

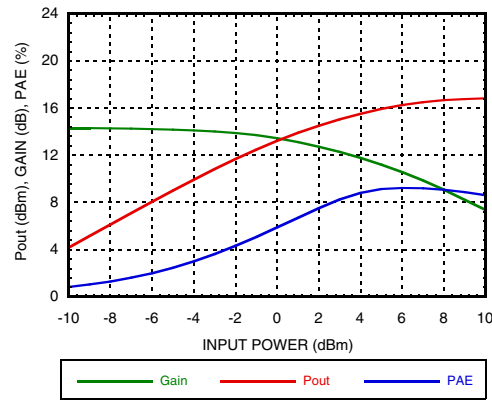

Power Compression @ 18 GHz

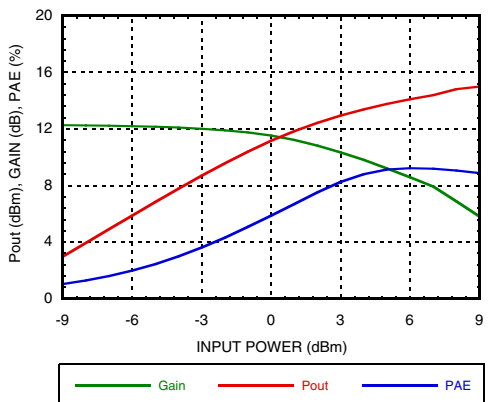

Noise Figure, Gain & Power vs. Supply Voltage @ 12 GHz

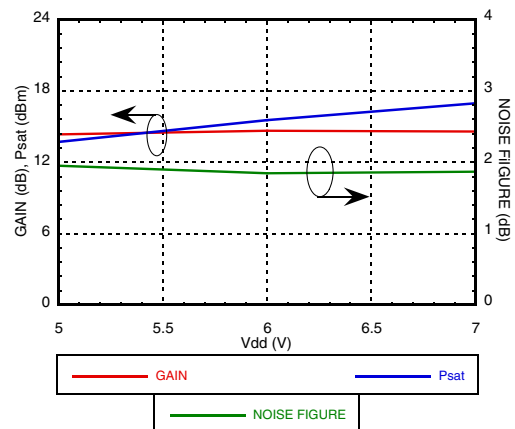

**GaAs pHEMT MMIC LOW NOISE
AMPLIFIER, 0.3 - 20 GHz**

Data taken with Vdd applied to pin 2.

**Noise Figure, Gain & Power vs.
Supply Current @ 12 GHz**

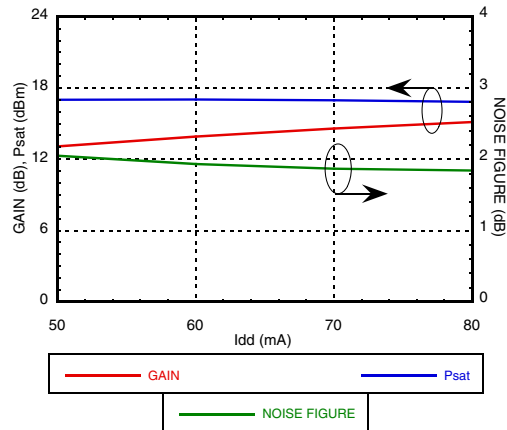



GaAs pHEMT MMIC LOW NOISE AMPLIFIER, 0.3 - 20 GHz

Data taken with Vdd applied to bias tee at pin 21.

Broadband Gain & Return Loss [1]

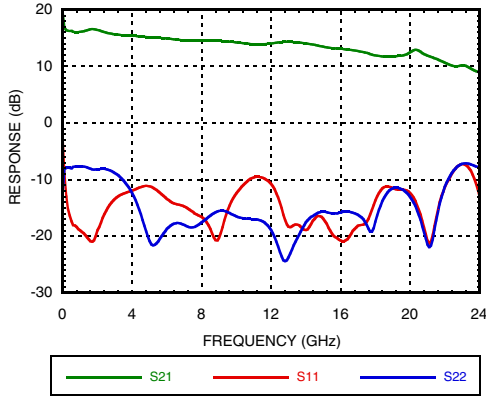

Gain vs. Temperature [1]

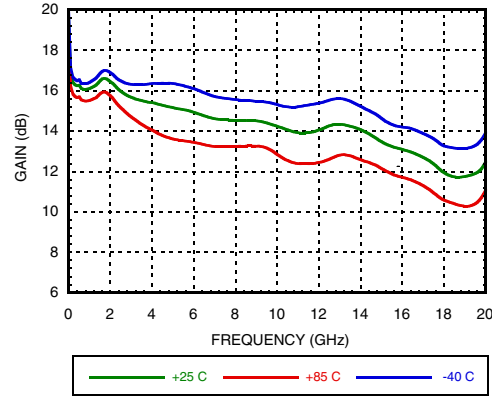

Noise Figure vs. Temperature [1]

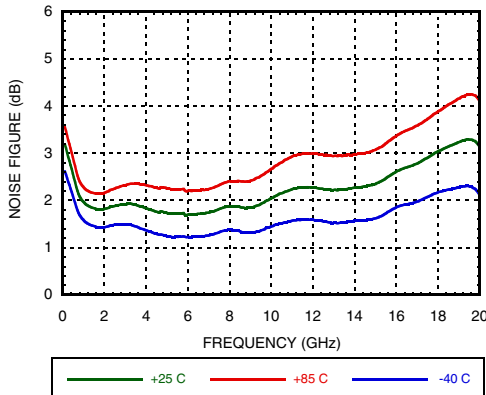

Output IP3 vs. Temperature [1]

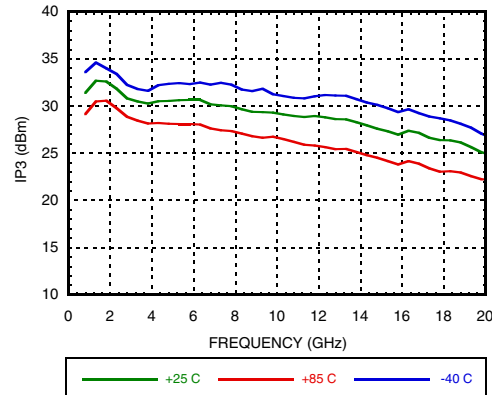

P1dB vs. Temperature [1]

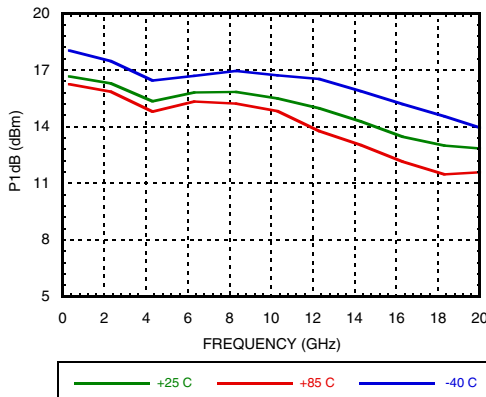

Psat vs. Temperature [1]

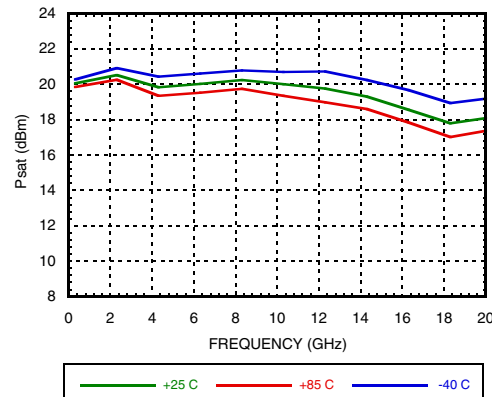

[1] Vdd= +4V, supply to bias tee.

**GaAs pHEMT MMIC LOW NOISE
AMPLIFIER, 0.3 - 20 GHz**
Absolute Maximum Ratings

Drain Bias Voltage (Vdd)	+10V
Drain Bias Voltage (RF out / Vdd)	+7V
RF Input Power	+18 dBm
Gate Bias Voltage, Vgg1	-2V to +0.2V
Channel Temperature	175 °C
Continuous P _{diss} (T = 85 °C) (derate 37.1 mW/°C above 85 °C)	3.34 W
Thermal Resistance (Channel to die bottom)	26.9 °C/W
Storage Temperature	-65 to +150 °C
Operating Temperature	-40 to +85 °C
ESD Sensitivity (HBM)	Class 1A

Typical Supply Current vs. Vdd

Vdd (V)	I _{dd} (mA)
+5	70
+6	70
+7	70

 Adjust Vgg1 to achieve I_{dd} = 70 mA

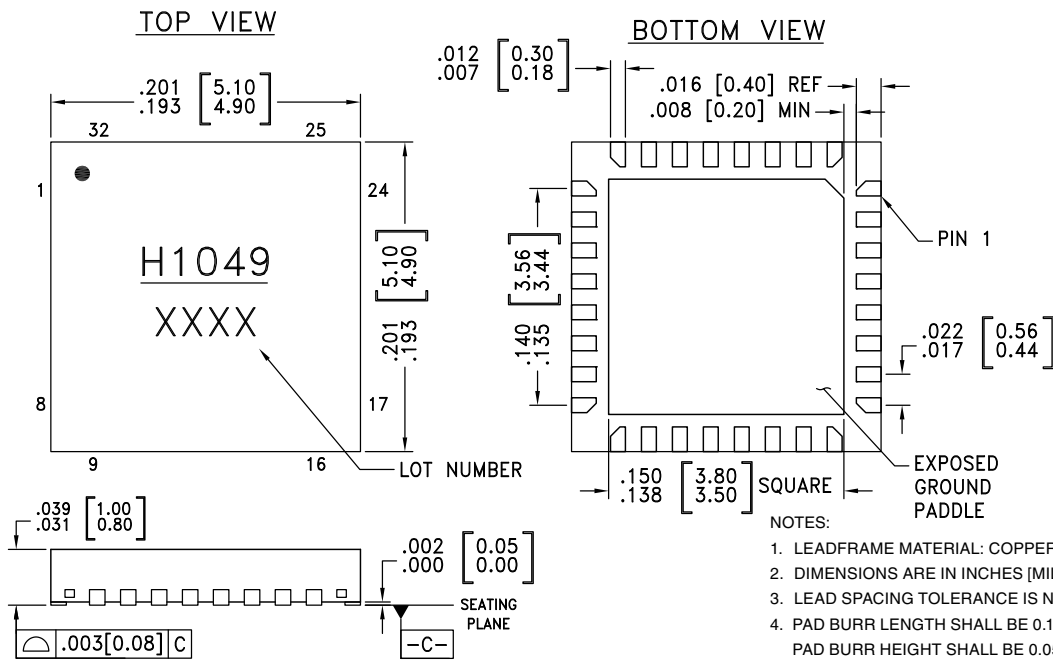
**ELECTROSTATIC SENSITIVE DEVICE
OBSERVE HANDLING PRECAUTIONS**
Outline Drawing

NOTES:

1. LEADFRAME MATERIAL: COPPER ALLOY
2. DIMENSIONS ARE IN INCHES [MILLIMETERS].
3. LEAD SPACING TOLERANCE IS NON-CUMULATIVE
4. PAD BURR LENGTH SHALL BE 0.15mm MAXIMUM.
PAD BURR HEIGHT SHALL BE 0.05mm MAXIMUM.
5. PACKAGE WARP SHALL NOT EXCEED 0.05mm.
6. ALL GROUND LEADS AND GROUND PADDLE MUST BE SOLDERED TO PCB RF GROUND.
7. REFER TO HITTITE APPLICATION NOTE FOR SUGGESTED PCB LAND PATTERN.



Package Information

Part Number	Package Body Material	Lead Finish	MSL Rating ^[2]	Package Marking ^[1]
HMC1049LP5E	RoHS-compliant Low Stress Injection Molded Plastic	100% matte Sn	MSL1	H1049 XXXX

^[1] 4-Digit lot number XXXX

^[2] Max peak reflow temperature of 260 °C

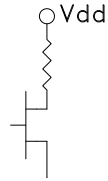
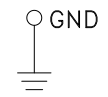
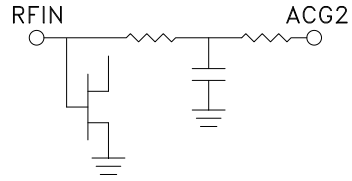
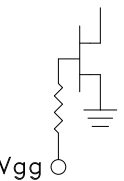
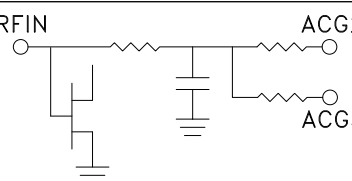
Pin Descriptions

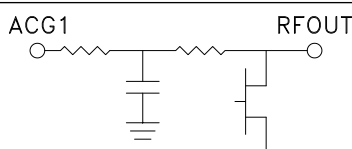
Pad Number	Function	Description	Interface Schematic
1, 3, 6-12, 14, 17-20, 23-29, 31, 32	N/C	No connection required. The pins are not connected internally; however, all data shown herein was measured with these pins connected to RF/DC ground externally.	
2	Vdd	Power supply voltage for the amplifier. External bypass capacitors 100 pF, and 0.01 uF are required.	
4, 22	GND	These pins and the exposed ground paddle must be connected to RF/DC ground.	
5	RFIN	This pin is DC coupled and matched to 50 Ohms.	
13	Vgg	Gate control for amplifier. External bypass capacitors 100 pF, 0.01uF, and 4.7 uF are required. Adjust voltage to achieve typical I _{dd} .	
15, 16	ACG3, ACG2	Low frequency termination. External bypass capacitors 100 pF are required.	
21	RFOUT/Vdd	This pin is DC coupled and matched to 50 Ohms.	
30	ACG1	Low frequency termination. External bypass capacitor 100 pF required.	

Evaluation PCB

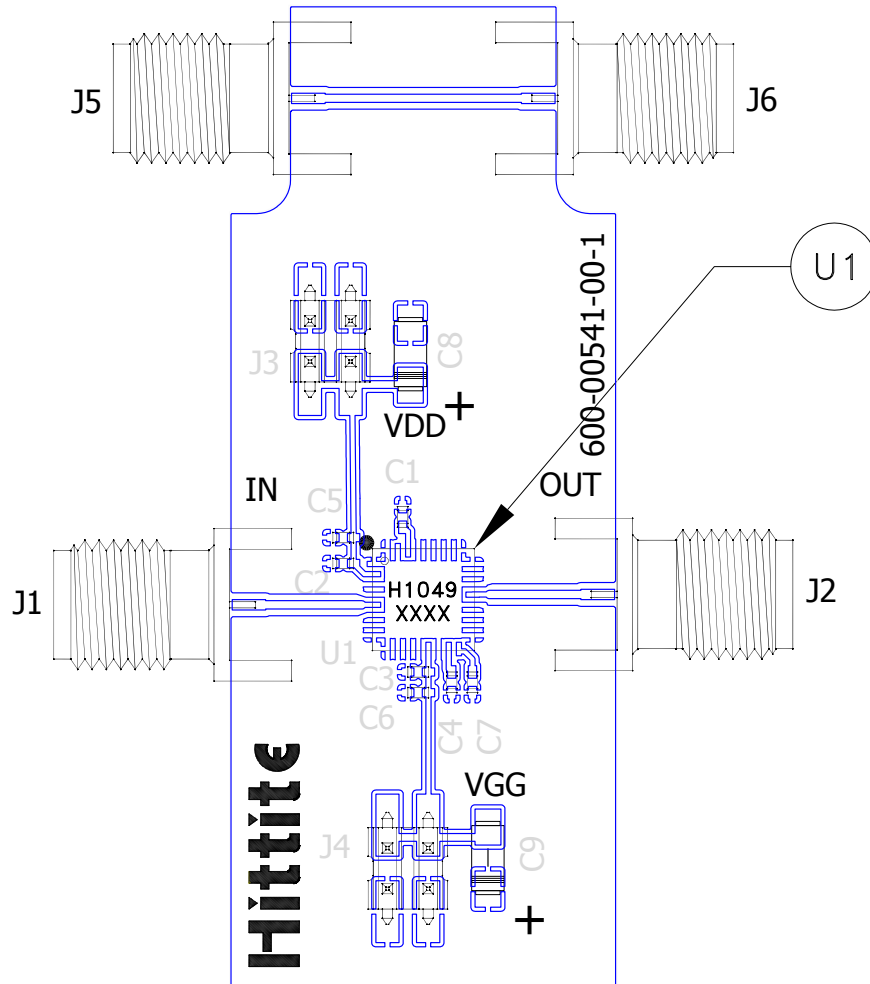

List of Materials for Evaluation PCB EV1HMC1049LP5 [1]

Item	Description
J1, J2, J5, J6	PCB Mount SMA RF Connector.
J3, J4	DC Pins.
C1 - C4	100 pF Capacitor, 0402 Pkg.
C5 - C7	10000 pF Capacitor, 0402 Pkg.
C8 - C9	4.7 uF Capacitor, Tantalum.
U1	HMC1049LP5E.
PCB [1]	600-00541-00-1 Evaluation PCB.

The circuit board used in the application should use RF circuit design techniques. Signal lines should have 50 Ohm impedance while the package ground leads and exposed paddle should be connected directly to the ground plane similar to that shown. A sufficient number of via holes should be used to connect the top and bottom ground planes. The evaluation circuit board shown is available from Hittite upon request.

[1] Circuit Board Material: Rogers 4350 or Arlon 25FR

Evaluation PCB Schematic
